

Sinexcel

INTERSTELLAR EV AC CHARGER

User manual

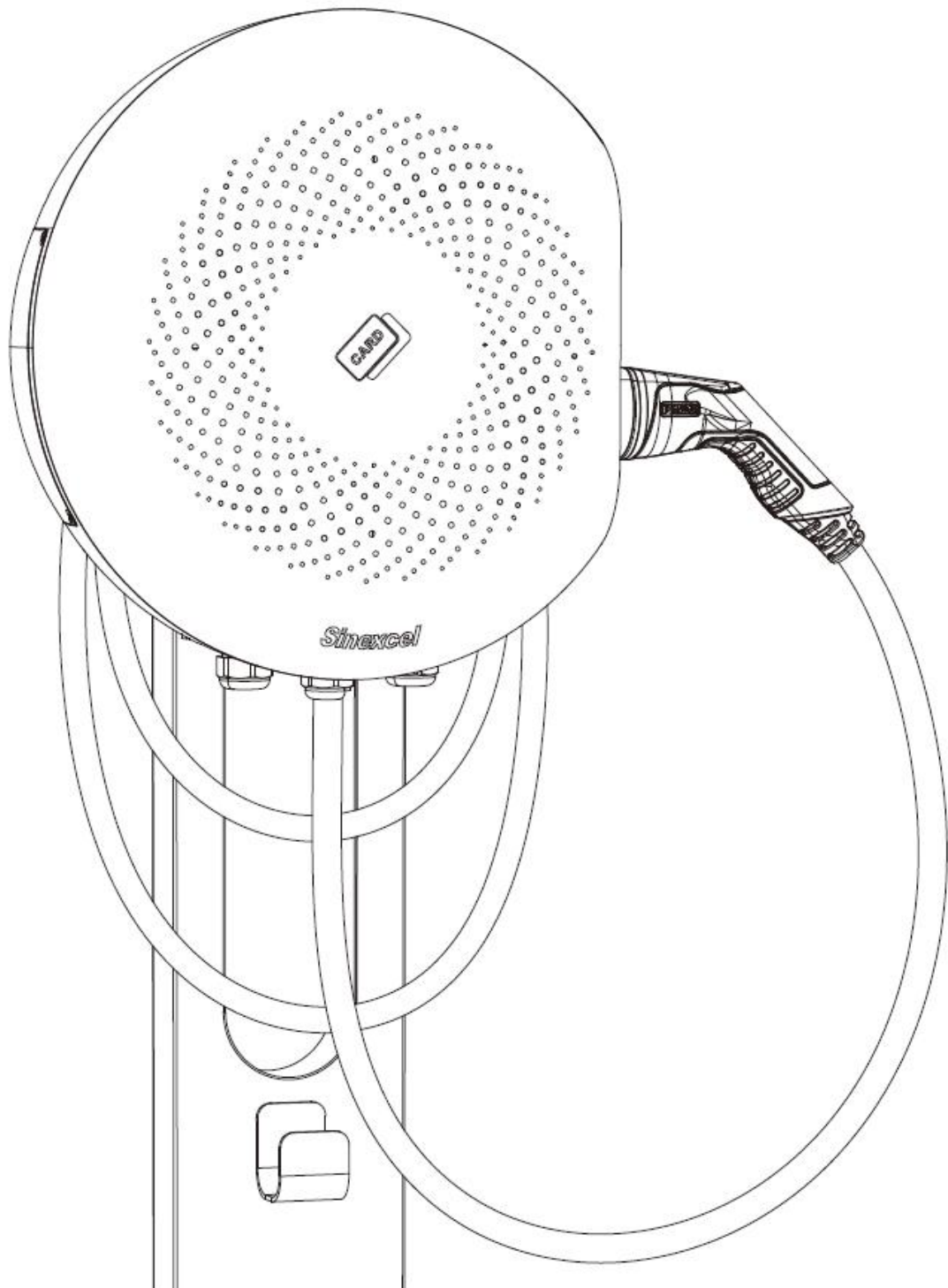

Contents

Contents	2
About the document	3
Symbol conventions	4
1. Safety	5
2. Description	6
3. Operation I.....	15
4. Sinexcel AC APP.....	28
5. Maintenance and cleaning	34
6. Troubleshooting	38
7. Cyber security	41
8. Warranty	42
9. Contact us	44

About the document







1) This user manual is specifically for the interstellar AC charger series products (SEA400/32Y-E-P or SEA230/32Y-E-P) developed and produced by Sinexcel, and provides comprehensive guidance for new energy vehicle users to use and maintain this charging device.

2) This manual will provide detailed product information and operating instructions for users. Please read the contents of the manual carefully before use this product and ensure that you understand all the instructions. Please store this manual in a safe place for maintenance personnel for the easy installation, operation and maintenance.

3) The copyright of contents, pictures, logos, symbols, etc. used in this manual are all owned by Sinexcel. Without authorization, it is forbidden to disclose, excerpt and copy part or all of the contents of this manual (including materials and publications).

4) The contents of this manual will be adjusted, revised and updated according to product upgrades. Please use this manual refer to the actual product purchased.

Symbol conventions

Symbol	Description
	Warning If you do not obey the instruction it might cause injury or death.
	Danger Risk of electrocution
	Caution of fire
	Note A note gives more details for easy use.
	It means that the machine cannot be discarded randomly after use and should be delivered to a dedicated recycling place, otherwise it may cause environmental pollution.
	Grounding identification This indicates that the product must be grounded during installation. If it is not properly grounded, it may cause death or serious injury.

1. Safety

1.1 General safety instructions

- This product is an integrated charger that can charge electric vehicles in indoor and outdoor areas.
- Please use and save the product information and accessories that are shipped with the device properly.
- If any problem or failure occurs during use, please consult the manufacturer directly. If the user resorts to a third party or a non-professional person for maintenance during the warranty period, any security consequences shall be borne by the user.
- The installation environment of charging equipment should be far away from fire and other dangerous sources.

1.2 Safety instructions for use

- Please read the user manual carefully before use, and strictly follow the steps.
- Without the permission of the manufacturer, it is strictly forbidden for the user to disassemble the product and do other improper operations. Any undesirable consequences caused by improper operation shall be borne by the user.
- Do not touch the charging plug or the charging socket of the electric vehicle. Keep the charging plug in a dry state. Do not touch the charging plug with water.
- Do not use the charging device when the connector is damaged or the insulation is damaged.
- Ensure that nothing remains in the charging plug and the charging socket on the vehicle side.
- Lock the door correctly after installation or maintenance operations.

In these situations, do not use the EVSE and contact to the manufacturer immediately :

- Damage on the enclosure
- Damage on the AC charger or connector
- Lighting hits the EVSE
- Accident or fire near the EVSE
- Water has entered the EVSE



If an emergency occurs during the operation of this product, please press the emergency button immediately. Do not use the emergency button in non-emergency situations!

2. Description

2.1 General description

Interstellar is an AC charger supplies electricity to the EV. The product adopts DLM system and IMD technology which makes strong charging performance with great quality. It has multiple safety protection functions with a protection rating of IP65, suitable for indoor or outdoor use.

2.2 Overview

2.2.1 Overview of EVSE, outside



The emergency button is not a reset button so it is forbidden to press it in non-emergency situations.



After pressing it, the EVSE will stop charging immediately. If the emergency button is pressed by mistake, please turn it gently in the direction of the arrow on the button to reset.



2.2.2 Overview of EVSE, inside

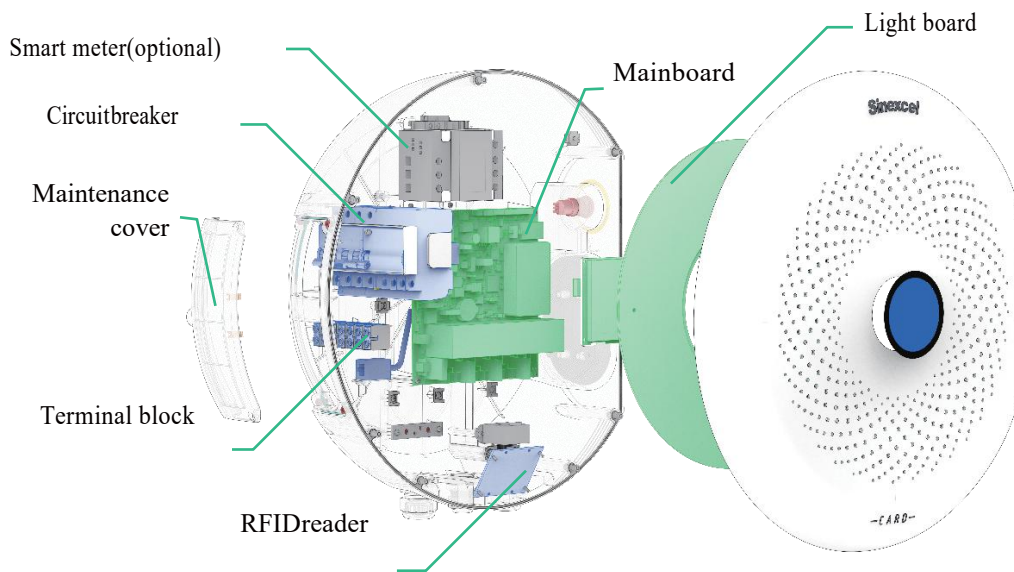

Part	Function
Maintenance cover	For maintenance and operation of on&off
Circuit breaker	For short circuit protection, overload protection and leakage protection
Smart meter	For metering
Mainboard	To control the EVSE
RFID reader	To start or stop charging session with the RFID card
Light board	To show the operation status of EVSE
Terminal block	To connect the cable of alternating current input from grid
Display	To show the operation status and parameter of EVSE

2.2.3 Pedestal

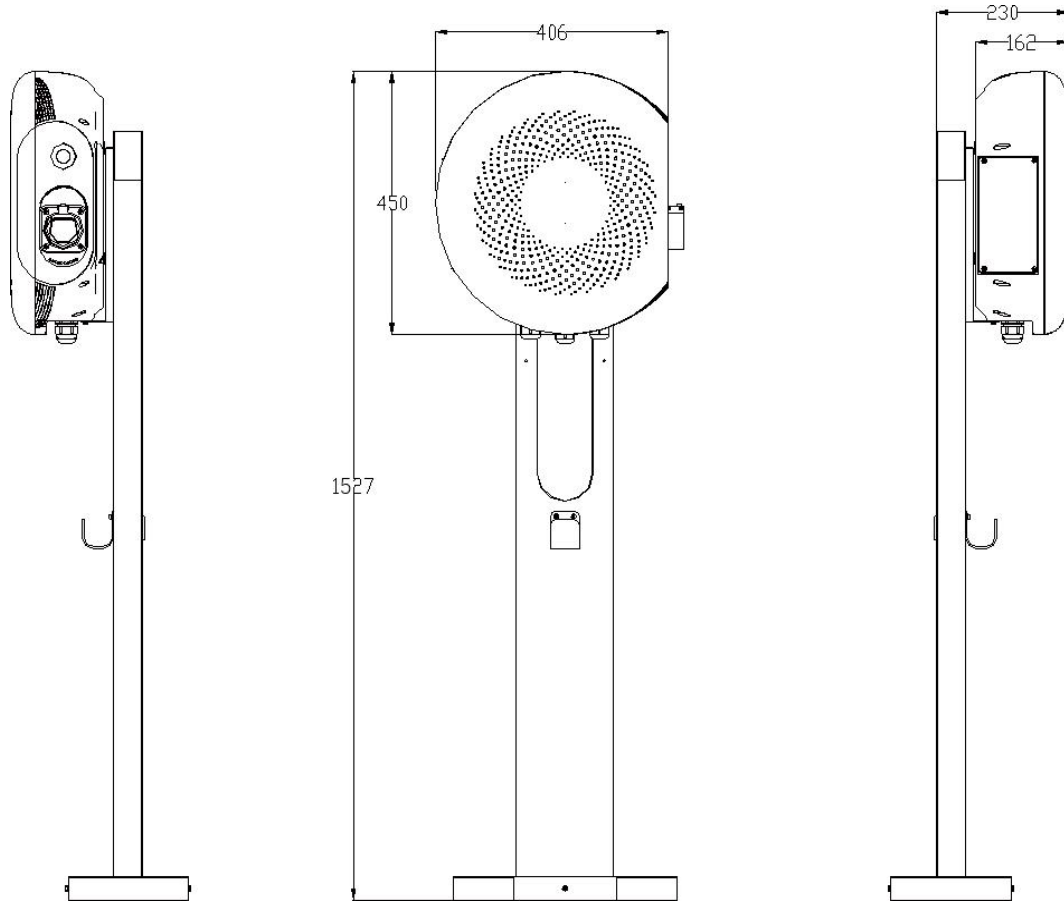

2.2.4 Nameplate

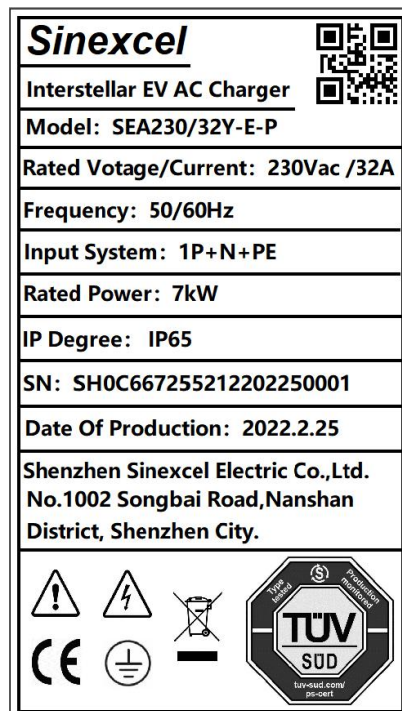
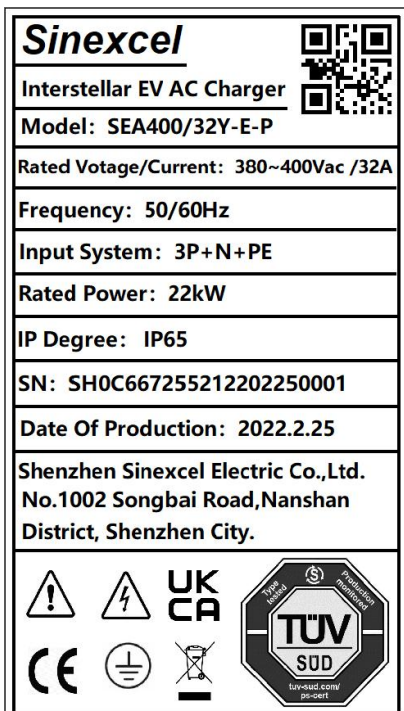

2.3 Specification

Interstellar (Residential Use)		
Rated Power	7kW	22kW
Input/Output Voltage	Single-Phase 230V	Three-Phase 400V
Input/Output Current	32A	32A
Weight	5KG	7.5KG
Dimensions	W406*H450*D162	
Frequency	50Hz	
Connector	IEC Type 2	
Cable Length	3m(5m optional)	
Charging Status Information	LED	
Authorization	Plug and Charge	
Metering	MID Meter(optional)	
Installation	Floor-mounted/Wall-mounted	
Protection Function	Over current protection, over/under voltage protection, over temperature protection, lighting protection, short circuit protection, etc.	
Protection Rating	IP65 /IK10	
Operation Temperature	-30 °C~+55 °C	
Operation Altitude	<2000m	
Relative Humidity	5%-95%	
RCD	Type A+DC 6mA	
EMC	Class B	
Certification	CE/TR25/TUV Mark/RCM	
Color	Black/White/Silver	

Interstellar (Commercial Use)		
Rated Power	7kW	22kW
Input/Output Voltage	Single-Phase 230V	Three-Phase 400V
Input/Output Current	32A	32A
Weight	5KG	7.5KG
Dimensions	W406*H450*D162	
Frequency	50Hz	
Connector	IEC Type 2	
Cable Length	3m (5m optional)	
Charging Status Information	LED/Display(optional)	
Authorization	NFC/RFID/Plug and Charge/APP (optional)	
Metering	MID Meter(optional)	
Communication Method	LAN/Wifi/4G(optional)	
Communication Protocol	OCPP1.6J(can be updated to 2.0)	
Installation	Floor-mounted/Wall-mounted	
Protection Function	Over current protection, over/under voltage protection, over temperature protection, lighting protection, short circuit protection, etc.	
Protection Rating	IP65/IK10	
Operation Temperature	-30 °C~+55 °C	
Operation Altitude	<2000m	
Relative Humidity	5%-95%	
RCD	TypeA+DC 6mA	
EMC	Class B	
Certification	CE/TR25/TUV Mark/RCM	
Color	Black/White/Silver	

Note 1 DC 6mA has an automatic start test function, which is performed every time when the relay is closed, and the intervals is not more than at least once a day.

2.4 Parts included in the delivery

Wall-mounted

No.	Parameter	Specification	Quantity
1	EVSE	Materials: PBT+PC	1
2	Wall-mounted template	L160*W299*D15mm	1
3	RFID card		2
4	Sabotage-proof hexalobular socket screw	Stainless steel M4X10	6
5	Cable ties		1
6	Product manual & installation manual		1
7	Product certification		1
8	Wrench	Stainless steel T20	1
9	Expansion tube	∅ 6*30mm (PE)	4
10	Cross recessed pan head self-drilling screw	Type C stainless steel ST4.2*30mm	4
11	EVSE electrical drawings	Business/home version	1

Pedestal

No.	Parameter	Specification	Quantity
1	Pedestal	L390*W210*H1423mm	1
2	Sabotage-proof hexalobular socket screw	Stainless steel M4X10	5
3	Expansion anchor bolts	Stainless steel M8x80	4
4	Plain washers	Stainless steel M8 plain washers	4
5	Product manual & installation manual		1
6	Wrench	Stainless steel T20	1

2.5 Product model numberS

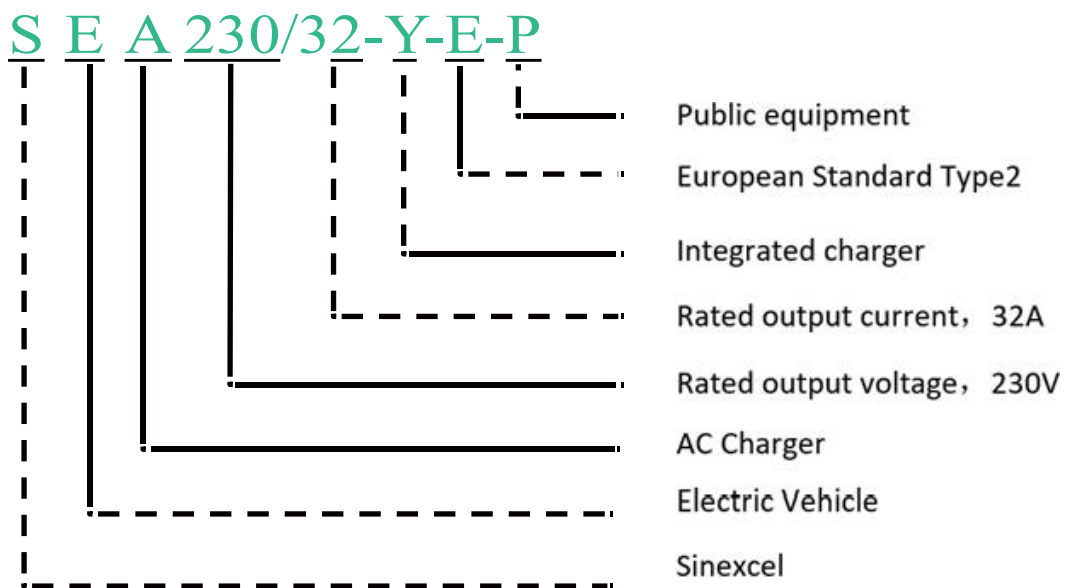
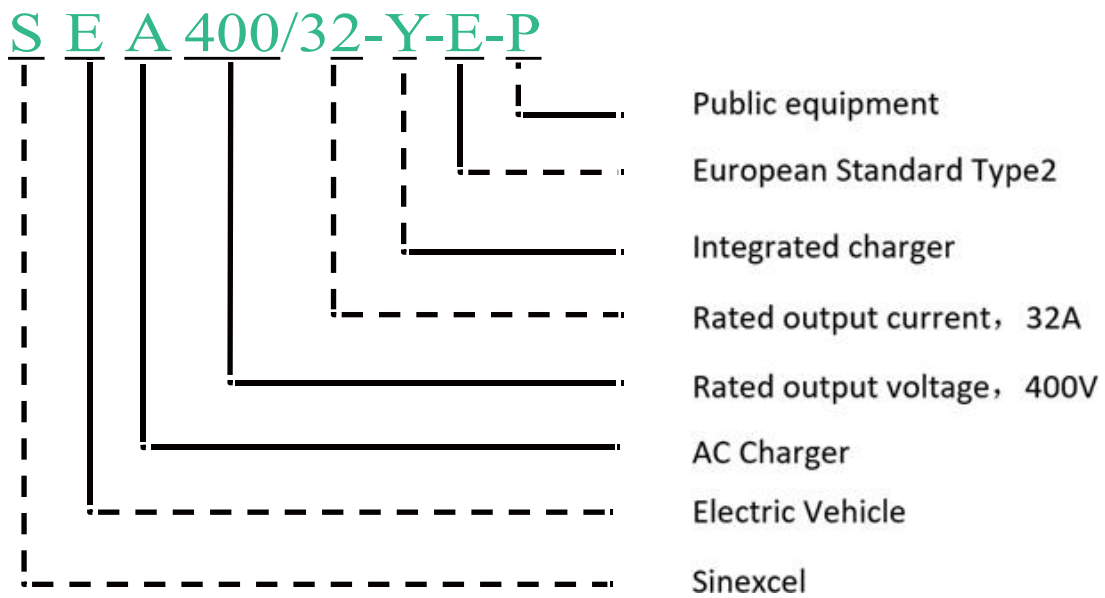

2.6 Standards

Interstellar is designed according to the European standard and meets the industrial standards in terms of function and performance. The specific technical standards are shown in the table below.

NO.	Standard number	Title
1	BS EN IEC61851-1:2019	Electric vehicle conductive charging system. General requirements
2	IEC62196-1:2014	Plugs, socket-outlets, vehicle connectors and vehicle inlets - Conductive charging of electric vehicles- Part 1: General requirements
3	IEC62196-2:2017	Plugs, socket-outlets, vehicle connectors and vehicle inlets. Conductive charging of electric vehicles.
4	IEC62955-2018	Residual direct current detecting device (RDC-DD) to be used for mode 3 charging of electric vehicles
5	IEC60947-2:2016	Low-voltage switchgear and control gear -Part 2: Circuit-breakers
6	EN 301 489-1 V2.2.0(Draft)	EMC standard for radio equipment and services; Part 1: Common technical requirements
7	EN 301 489-1 V2.1.1(Final draft)	EMC standard for radio equipment and services;Part 1: Common technical requirements
8	EN 301 489-52 V1.1.0(Draft)	EMC standard for radio equipment and services; Part 52: Specific conditions for Cellular Communication Mobile and portable (UE) radio and ancillary equipment
9	EN 61000-6-1:2007	EMC - Part 6 - 1: Generic standards-Immunity for residential, commercial and light-industrial environments
10	EN 61000-6-3:2007+A1	EMC - Part 6 - 3: Generic standards-Emission standard for residential, commercial and light-industrial environments

11	EN 62311:2008	Assessment of electronic and electrical equipment related to human exposure restrictions for electromagnetic fields (0 Hz-300 GHz)
12	EN 62479:2010	Assessment of the compliance of low power electronic and electrical equipment with the basic restrictions related to human exposure to electromagnetic fields (10 MHz to 300 GHz)
13	EN 61851-1:2011	Electric vehicle conductive charging system- Part 1: General requirements
14	EN 61851-22:2002	Electric vehicle conductive charging system -Part 22: AC electric vehicle charging station
15	EN 301511 V9.0.2	Global System for Mobile communications (GSM); Harmonized EN for mobile stations in the GSM 900 and GSM 1800 bands covering essential requirements
16	EN 300 330 V2.1.1	Short Range Devices (SRD); Radio equipment in the frequency range 9 kHz to 25 MHz and inductive loop systems in the frequency range 9 kHz to 30 MHz

3. Operation I

3.1 Preparation before operation

- 1) Ensure that there is no fire around the EVSE and the surrounding space is not blocked.
- 2) Ensure there is no damage on the cable.
- 3) Ensure that the EVSE is maintained regularly. Refer to section 4.
- 4) No need to set network or change any system settings following section 3.2/3.3.

3.2 Charging procedure (EVSE with display)

3.2.1 Connect to the connector

- 1) Take the charge cable from the enclosure or the hunger installed on the pedestal (refer to section 3.5) and connect it to the EV.
- 2) After the connector is inserted correctly, the EVSE will be ready for charging.

3.2.2 Standby screen

- 1) The display shows the standby screen as shown in the figure when the EVSE is in the idle status.
- 2) The lights on the enclosure turn from dark to green, as shown in the figure below.



3.2.3 Prepare to charge screen

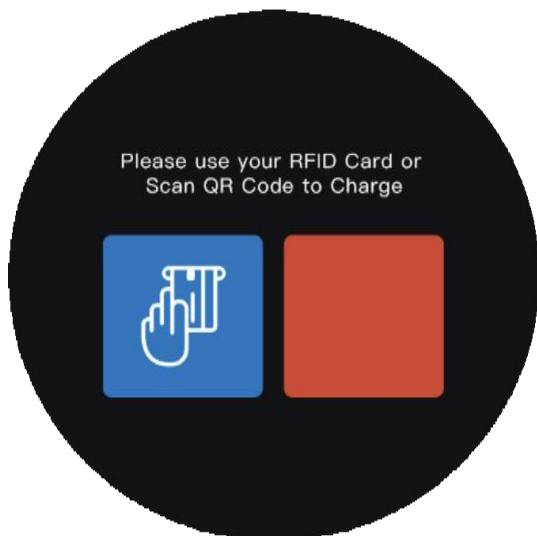

Authorize the use of EVSE by RFID card, password and operator APP.

3.2.4 Start to charge screen

- 1) The interface jumps to charging information screen when the EVSE start to charge, as shown in the figure below.
- 2) During the charging session, the lights on the enclosure turn from green to blue, as shown in the figure below.



3.2.5 Stop charging screen

- 1) During the charging session, use RFID CARD, password and operator APP can stop charging. When fully charged, the EVSE will automatically stop charging. In an emergency, it is able to cut off the power by pressing the emergency stop button.
- 2) When the charging cycle is completed, the display as shown in the figure below.



- 3) When charging completed, lights on the enclosure turn from blue to dark. The user can pull-off the connector and wrap it around the enclosure or put it back on the hanger.

3.3 Charging procedure (EVSE without display)

3.3.1 Connect to the connector

- 1) Take out the connector from the enclosure or the hanger installed on the pedestal (refer to section 3.5) and connect it to the EV.
- 2) After the connector is plugged in correctly, the EVSE will be ready for charge.

3.3.2 Start to charge

There are two ways to charge which depend on customer's requirement.

- The first one is to tap the RFID CARD on the card reader to start charging.
- The second way is "Plug and Charge". Plug in the connector (refer to section 3.2.1) and the charging process initiates.

3.3.3 Stop charging

- 1) During the charging session, using RFID CARD, password, operating on the APP or unplugging the connector will stop charging. When the car is fully charged, the EVSE will automatically stop charging. In case of emergency, pressing the emergency stop button will cut the power off.
- 2) When charging completed, blue light on the enclosure will be turned off. The user can unplug the connector and put it back to the enclosure or hanger.

3.4 Description of the display screens (optional)

3.4.1 How to enter the administrator interface

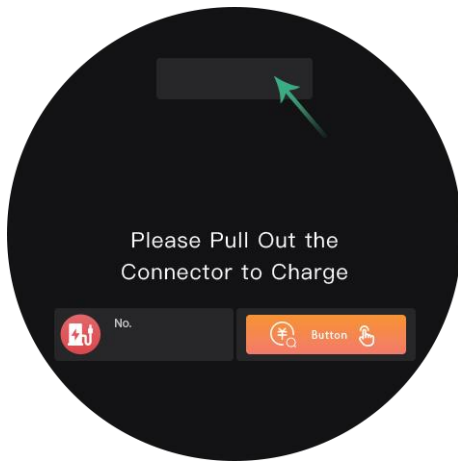

Tap the top of the screen, as the green arrow shows, twice.

The numeric keypad will show up. Then enter the password 123456 to get into the administrator interface.



3.4.2 How to set time



Choose manufacturer setting.



Tap the Set Time button and the numeric keypad will show up. Enter the correct time in the sequence of year, month, day, hour, minute and second (yyyy.MM.dd.HH.mm.ss). Please note that dots should be entered between each data.

For example, for 2021/12/1 17:30:19, enter 21.12.1.17.30.19

3.4.3 How to set time zone



Choose manufacturer setting.



Enter the parameter to set the time zone.

The first and second digits means hours

The third and fourth digits means minutes

The last digit means either increment(1) or subtraction(0)

For example:

12001: Subtract 12 hours and 0 minutes for UTC -12:00

8300: Increase 8 hours 30 minutes for UTC +8:30

3.4.4 How to connect to a WiFi network

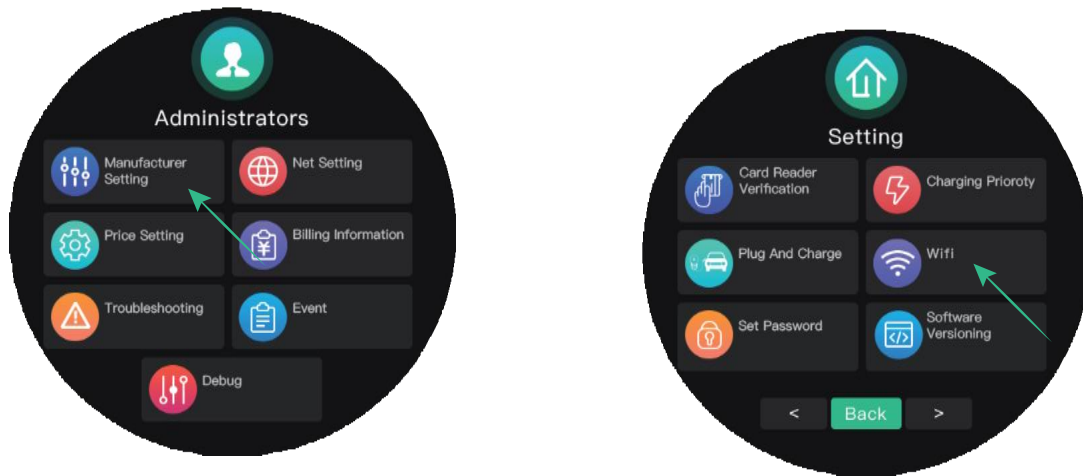

Choose the manufacture setting to enter the setting interface and tap WiFi button.



Enter "1" to turn on WiFi.



Get back to the Administrator interface and tap the Net Setting button.



Enter the name and the password of WiFi to connect to the WiFi network.

3.4.5 How to connect to 4G or Ethernet

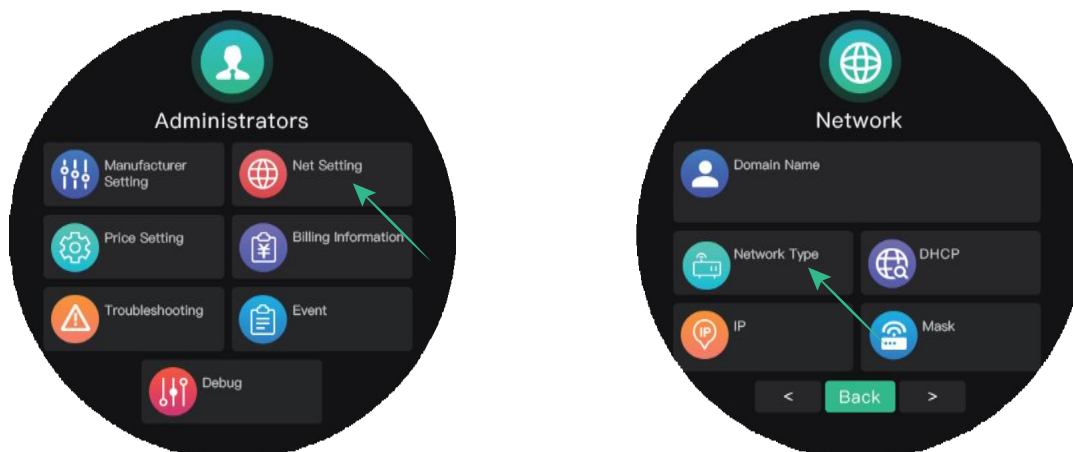

Choose Net Setting to enter the Network interface and tap the network type button.



Set the parameter to choose the network type.

“0” means connect to 4G;

“1” means connect to Ethernet.

Enter the number to choose the network type that you want to connect to.

3.4.6 How to connect a Bluetooth

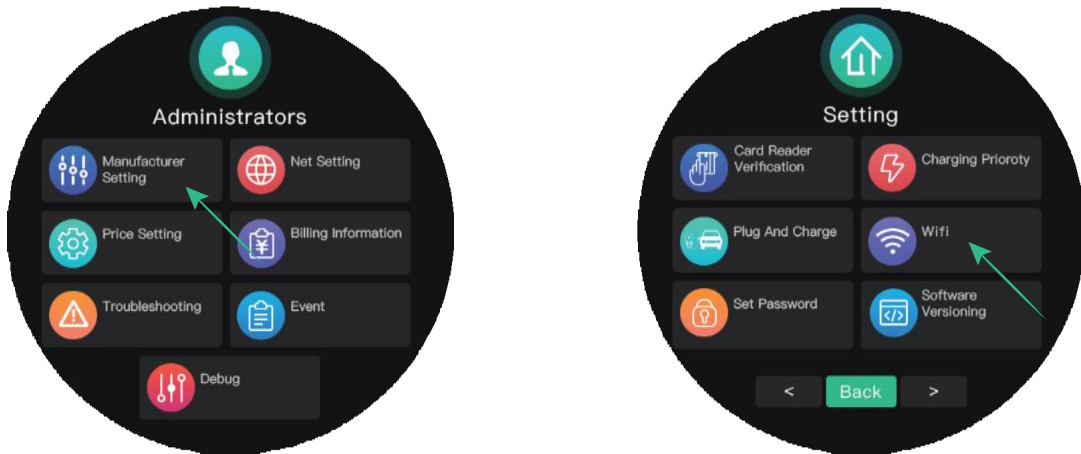

Choose manufacturer setting to enter the Setting interface and tap WiFi button.



Enter “0” to turn on Bluetooth.

There is no interface for connecting to Bluetooth on the screen of EVSE. The user should find the EVSE on your own vehicle. Turn on Bluetooth on the vehicle you want to connect to, then the device lists will be showed up on the Bluetooth screen on the vehicle, and choose the device named as “sinexcel charger” to connect the Bluetooth between the two.

3.4.7 Description of icons of idle screen

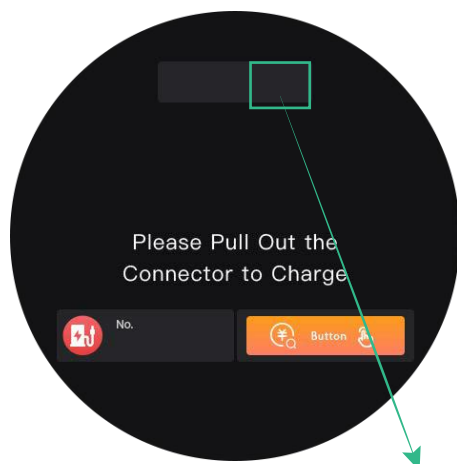

1) These icons mean the EVSE has connected to 4G/Ethernet/Bluetooth/WiFi



2) These icons mean the EVSE has connected to 4G/Ethernet/Bluetooth/WiFi and the platform.



3) These icons mean the EVSE fails to connect to 4G/Ethernet/Bluetooth/ WiFi



3.5 Cable Management System

The cable management system is designed to hang the cable up and keep it clean. The user can wrap the EV charge cable around the hanger which is installed on the pedestal for storage.

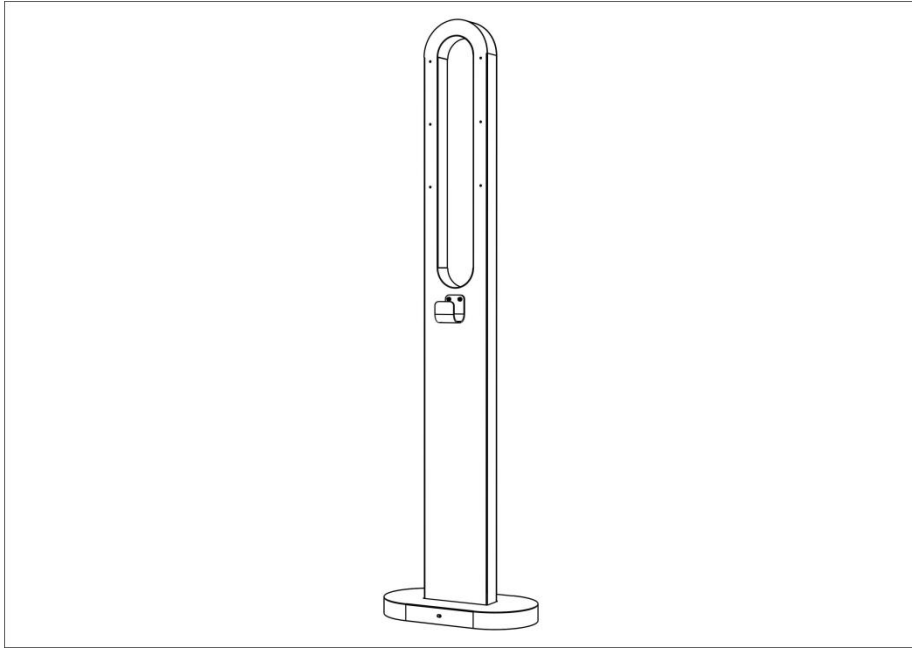

4. Sinexcel AC APP

4.1 Download APP

Apple users should search for Sinexcel AC download and installation in Apple Store, and Android users should search for Sinexcel AC download and installation in Google Store.



4.2 Register/Sign in

You need to register to log in to Sinexcel AC APP for the first time.

A screenshot of a user authentication form. At the top, there are two links: "Log in" and "Register". The "Register" link is circled in red, and a red arrow points to it from the right. Below the links are two input fields: "Enter email" with a person icon and "Enter password" with a lock icon. A "Forgot my password" link is positioned below the password field. At the bottom of the form is a large green button labeled "Log in". Below the button, there is a line of text: "By logging in or registering, you have read and agreed [missing {{0}} value] «User Agreement» and «Privacy policy»".

Log in Register

Enter email

Enter password

Forgot my password

Log in

By logging in or registering, you have read and agreed [missing {{0}} value] «User Agreement» and «Privacy policy»

4.3 Binding

Enter the App interface, as shown in the figure, and click "+" in the upper right corner to enter the binding page. Enter the user-defined name, click the charger model and select interstellar; the Charger number is bound by scanning the code, and the specified QR code is scanned to automatically obtain the charger number; click "Bind Now" to start binding the charger. During the binding process, the location permission needs to be enabled, and the App will also remind you to enable the location; A charger can only be bound to one account, and one account can be bound to multiple chargers.

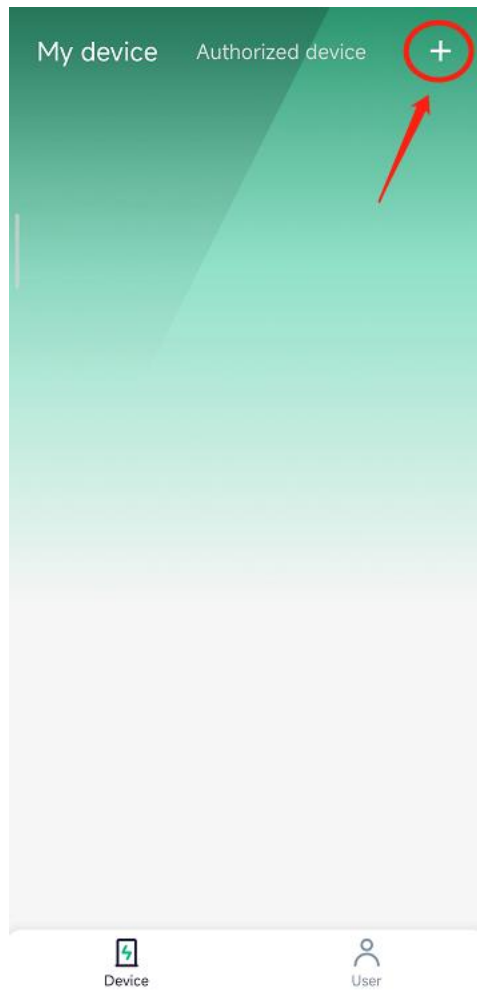

4.4 Unbinding

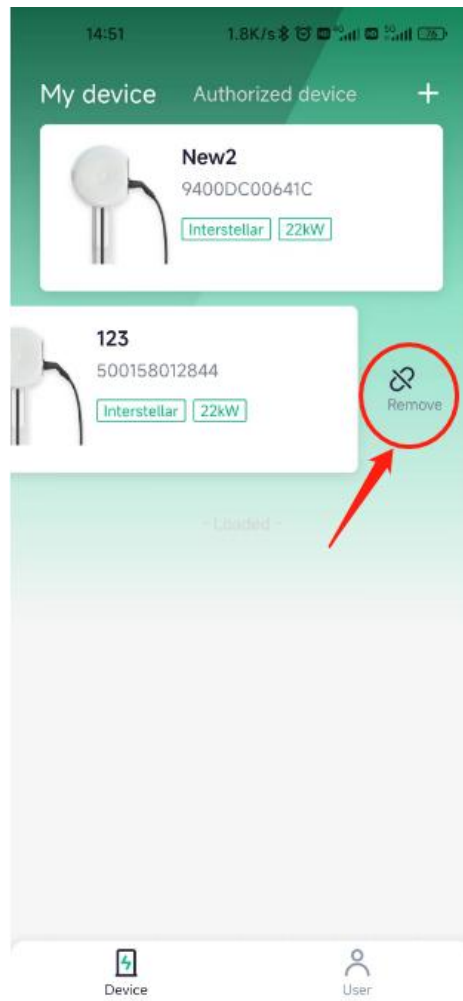

4.5 Authorization management

Click "Authorization Management" in the "Device Details" interface, click "Add Authorization" in the upper right corner, enter the email account of the authorized user (registered), and click "Save and Apply" to complete the authorization; The authorized user has some functions such as start/stop charging, timed charging, plug and play charging and data analysis.

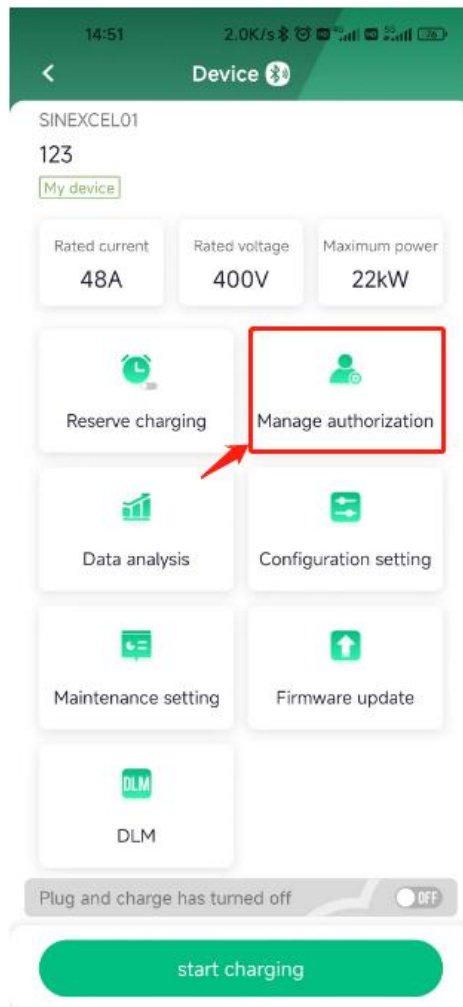

4.6 Parameter query

Click "parameter setting" under the "equipment details" interface, and the following parameters can be viewed or set under this interface (note: users should not modify parameters without authorization to avoid unnecessary trouble)

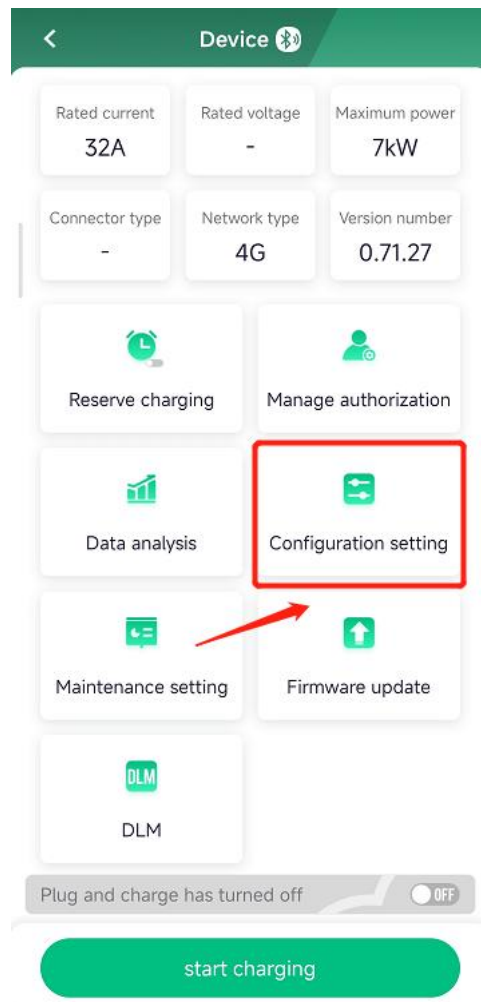

4.7 Firmware update

Click "Firmware Upgrade" under the "Device Details" interface. Select the version, upgrade or downgrade to the corresponding version of software as required, and then click Upgrade or downgrade. When you are in the process of software upgrade, please wait patiently for the completion of the upgrade process, which is estimated to be 2-3 minutes. After the upgrade is completed, the charger will restart automatically. At this time, the APP needs to reconnect the charger. After that, check the equipment version under the "Equipment Details" interface to confirm whether the upgrade is succeed.

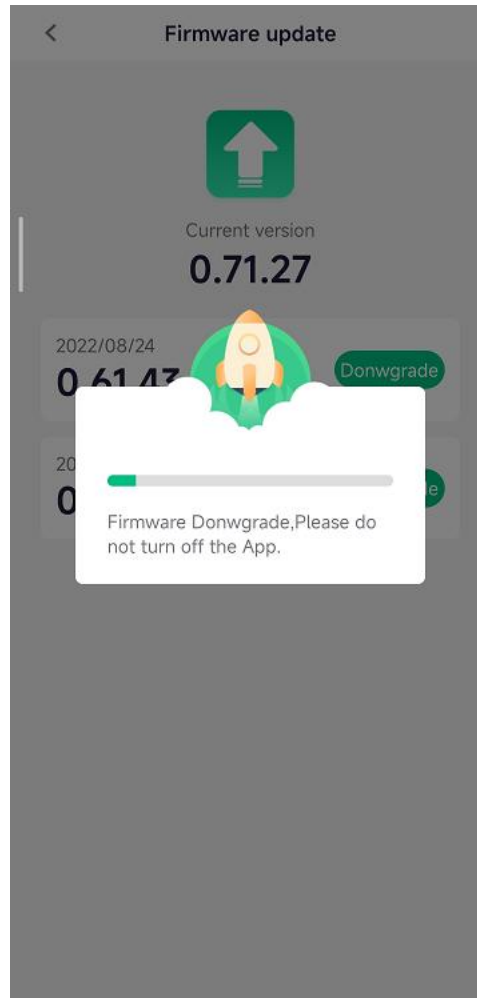

5. Maintenance and cleaning

5.1 Maintenance and cleaning

- 1) Please check whether there is damage on the cabinet cover, outlets, cables and connectors every time before use.
- 2) Please check whether there is damage on the display every time before use.
- 3) Please use low pressure water to clean the enclosure of the EVSE every 4 months. In case of stubborn dirt, please apply a cleaning agent and clean it manually. Do not use corrosive tools.

Note: If you see any damage, please contact the manufacturer. Refer to chapter 8.

5.2 Disassemble the connector cable

- 1) Remove the cover panel on the housing.

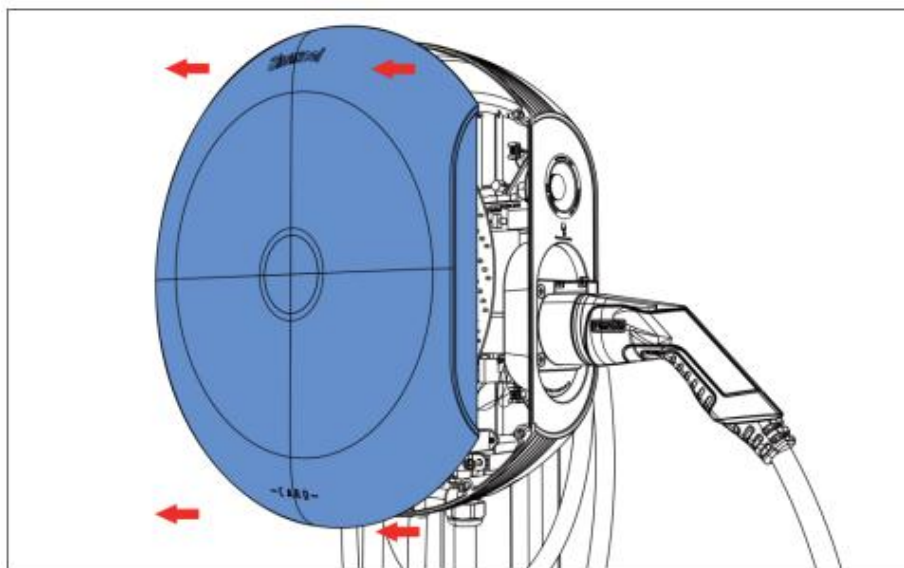

2) Unscrew screw B on 2PIN connector A. Disconnect CP/PP cable.

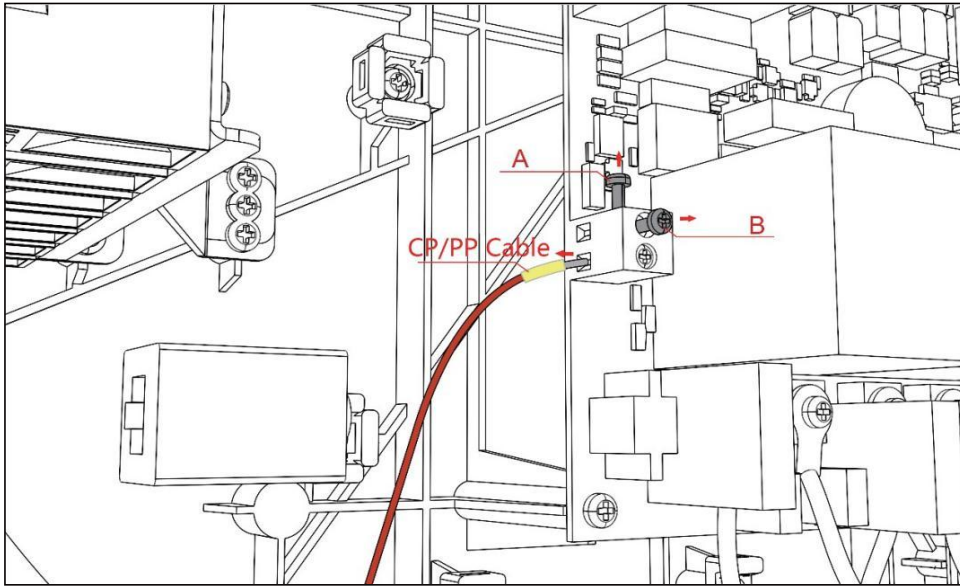

3)

7kW: Unscrew screw C, D on circuit board and G on copper busbar.

Disconnect neutral wire (H), L1(I) and earth wire(L).

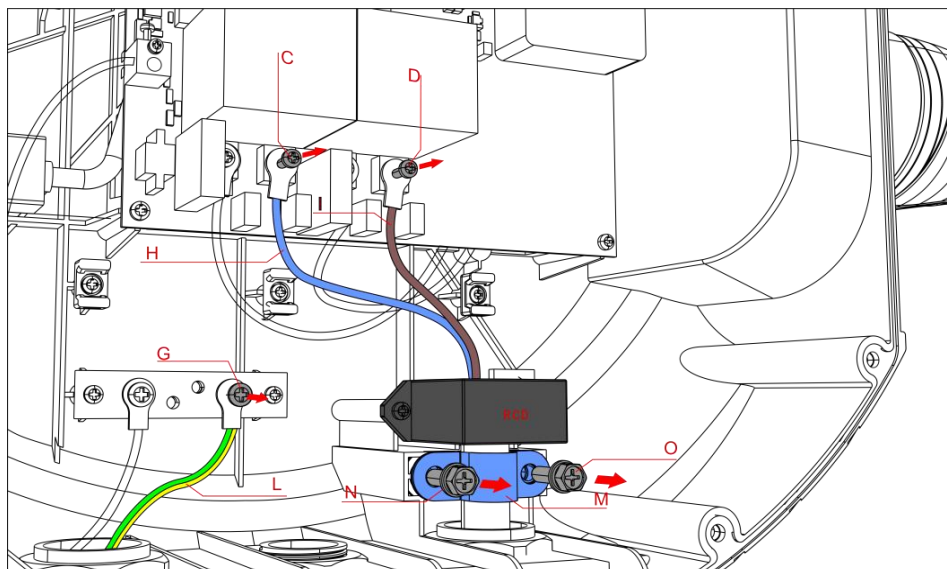

22kW: Unscrew screw C, D, E, F on circuit board and G on copper busbar.

Disconnect the neutral wire (H), L1 (I), L2 (J), L3 (K), and the earth wire (L).

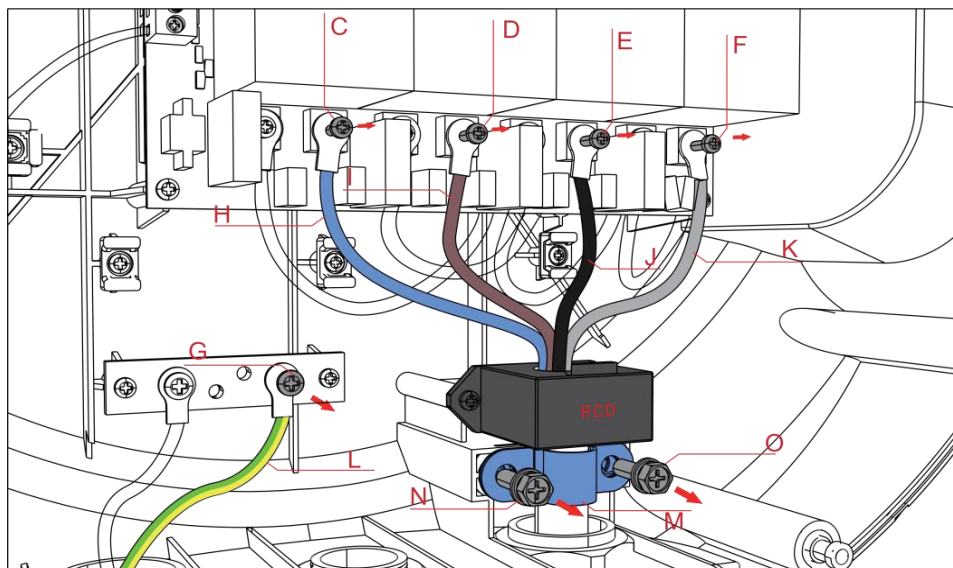

4) Unscrew screw N and O which are used to fix hose clamp M.

5) Untighten the water-proof clamp P and pull out the cable.

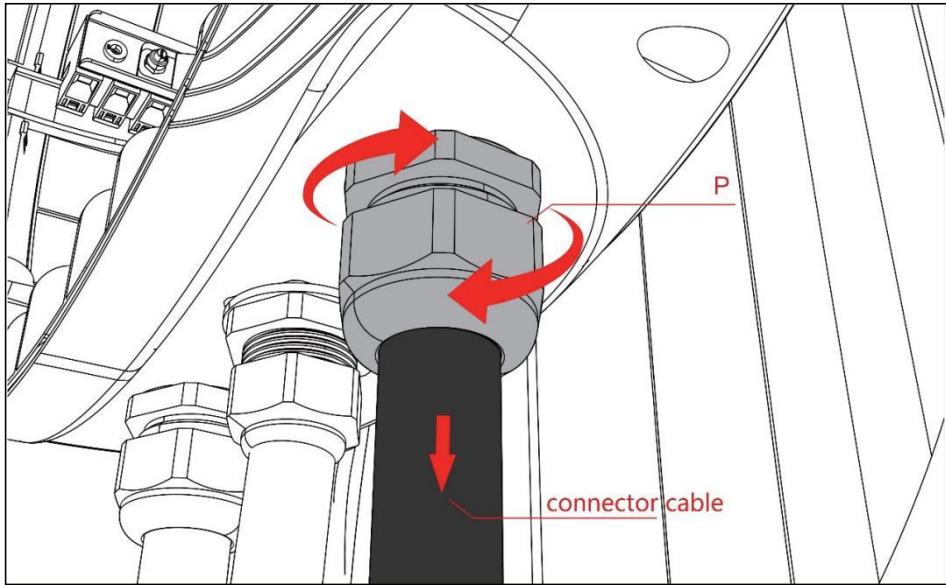

5.3 Assemble the connector cable

Reverse to the process documented in 5.2.

6. Troubleshooting

6.1 Error code

Error code	Problem	Possible cause	Possible solution
Error 1	Emergency shutdown	In an emergency situation, the emergency button is pressed	<ol style="list-style-type: none"> 1. Check whether the emergency stop button is pressed. If it is pressed, reset the emergency stop; 2. Power off and open the cover, check whether the emergency stop terminal is loose, and if it is loose, plug it in again;
Error 2	Over voltage	The voltage is over than 257V	Check whether there is over voltage at power supply side.
Error 3	Under voltage	The voltage is under 183V	Check whether there is under voltage at power supply side
Error 4	Over current	35A The output current is over than 35A	Contact technical support
Error 5	N-phase relay contact point adhesion	The contact point of the connector overheated, causing adhesion and malfunctioning	Contact technical support
Error 6	L-phase relay contact point adhesion	Contactor contacts overheated, causing adhesion or malfunctioning	Contact technical support
Error 7	Meter communication failure	Error of the meter ID or damage on meter	Plug and unplug the meter communication cable again

Error 8	RFID card reader communication failure	Damage on the RFID card reader	Reseat and unplug the reader communication cable
Error 9	Over temperature	The internal temperature is higher than the protection threshold value.	Contact technical support
Error 10	Electric leakage	The Residual Current Monitor fails or residual current exists	Contact technical support
Error 11	Earth fault	The EVSE is not properly grounded	Check whether the ground wire is connected

Note: If you can't solve the problem by this document, please contact the manufacturer.

6.2 LED description

Status	Light description
Standby	Green -constant light
Connection	Blue-constant light
Charging	Blue-breathing light
Emergency shutdown	Red-constant light
Over/under voltage	Blue-2s flashing light; Red -constant light
RCD fault	Red-2s flashing light
Over current	Red-500ms flashing light
Relay adhesion	Red-constant light; Green-500ms flashing light
Meter communication failure	Red-constant light; Green-2s flashing light
Earth fault	Red-constant light; Blue -500ms flashing light
RFID card reader warning	Green -2s flashing light
Disconnect to the platform	Green-constant light; Blue-2s flashing light

7. Cyber security

7.1 Warning

Please use the security protocol mentioned in this manual to connect. Otherwise, there will be network security risks.

7.2 Operator platform

As the EVSE starts to work, it is connected to the Sinexcel charging facility platform, which can realize functions such as remote management, diagnosis, configuration, maintenance, and upgrade.

Sinexcel requires the use of secure communication protocols (HTTPS/TLS1.2 or higher secure cryptographic algorithms) for product communication. If a consumer insists on using non-secure communication protocols, he/she needs to sign a disclaimer. All accidents and losses caused by the use of non-secure communication protocols shall be borne by the user.

7.3 Cyber security disclaimer

The owner is responsible for providing and continuing to ensure a secure connection between the product and the network or any other networks. And the owner also has to formulate and maintain appropriate measures (including but not limited to installing firewalls, authentication, encrypting data and using anti-virus programs, etc.) to protect products, networks, systems and interfaces from any types of security breaches, unauthorized access, interference, intrusion, or information leakage and loss.

SINEXCEL ELECTRIC CO., LTD is not liable for damages and losses related to such security breaches, any unauthorized access, interference, intrusion, leakage and theft of data or information.

Although Sinexcel provides functional testing for products and updates, the owner should develop testing procedures for product updates or other major system updates (including but not limited to code changes, configuration file changes, third-party software updates or patches, hardware replacement, etc.) to ensure that the security measures implement are not compromised.

8. Warranty

8.1 Warranty period

The warranty period of this product is subject to the contract.

During the warranty period, the owner should show the invoice, date and SN of the product to our service personnel when repairment is needed. At the same time, the nameplate on the product should be clearly visible, otherwise Sinexcel has the right not to repair it.

8.2 Warranty conditions

- The user has completely complied with the storage, installation and use rules stipulated in this instruction, but the product still has quality problems.
- After the product was shipped from the factory, the user finds that the product or accessory parts were damaged due to transportation reason during unpacking inspection, and staffs should confirm or keep the damaged parts and related pictures.
- For products that fail during the warranty period, our company will repair or replace products of the same type free of charge; the defective machine after replacement shall belong to the manufacturer.

8.3 Liability statement

Requirements for users and operators:

- Operate the EVSE under the premise that the protective measures are fully implemented, and ensure the correct installation and regular maintenance of the protective facilities.
- Prepare emergency plans and instruct people how to deal with emergencies.
- Prepare the installation environment according to the requirements described in this manual.
- Ensure that the EVSE has enough space for passage and maintenance.
- It is necessary to be fully aware that changes and changes without the permission of Sinexcel may affect the user's operating authorization and may also affect the warranty.

8.4 Disclaimer

The EVSE needs to be used normally within a certain range of conditions. Sinexcel will not be responsible for accidents or damage caused by one of the following situations:

- Products and accessories not marked by our company;
- The product or component has exceeded the warranty period of our company;
- Failures and damages caused by environmental use that do not follow the instructions (such as the temperature is too high, too low, too humid or dry, the altitude is too high, the voltage or current is unstable, etc.);
- Failure or damage caused by installation, repair, modification or disassembly by a third party's after-sales service personnel without the consent of the company;
- Normal wear, abrasion, cracking and soaking, etc;
- Failure or damage caused by accidents or human causes (operation errors, scratches, handling, bumps, access to improper voltage, etc.), transportation damage;
- Failure or damage caused by natural disasters and other force majeure (such as earthquakes, lightning strikes, fires, abnormal voltages, etc.);

9. Contact us

Our company provides customers with a full range of technical support, if you have any questions about the product or technical problems, please feel free to contact us.

Shenzhen Sinexcel Electric Co., Ltd.

Address: 1002 Songbai Rd, Nanshan, Shenzhen, China

Website: <https://en.sinexcel.com/>

Tel: 0755-8651-1588/400-0055-776-2

E-mail: sales@sinexcel.com

Sinexcel

Shenzhen Sinexcel Electric Co, .Ltd.
Stock code: 300693

Address: 6th Building , 2nd District ,
Baiwangxin High-tech Industry Park,
Songbai Road, Nanshan District,
Shenzhen.